



29 rue du 14 juillet  
67980 - Hangenbieten  
FRANCE  
Tel. : +33 3 88 48 53 00  
[www.soframe.com](http://www.soframe.com)

DEFENCE



© SOFRAME - 05/2022 - D137228 - GB - Non-contractual photos - All descriptions and characteristics are indicative and non-binding.

# ARIVE

## Armoured Infantry Vehicle



DEFENCE

EN



## Technical characteristics

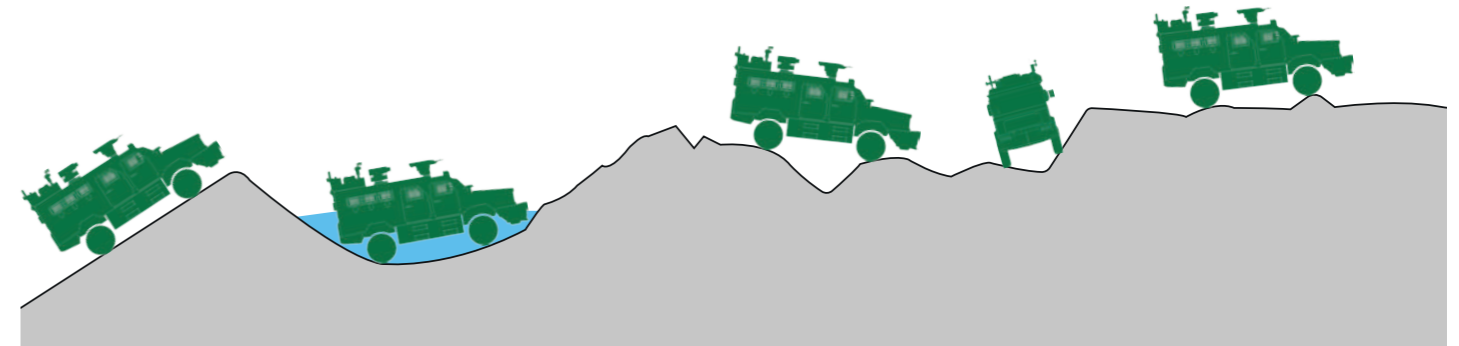
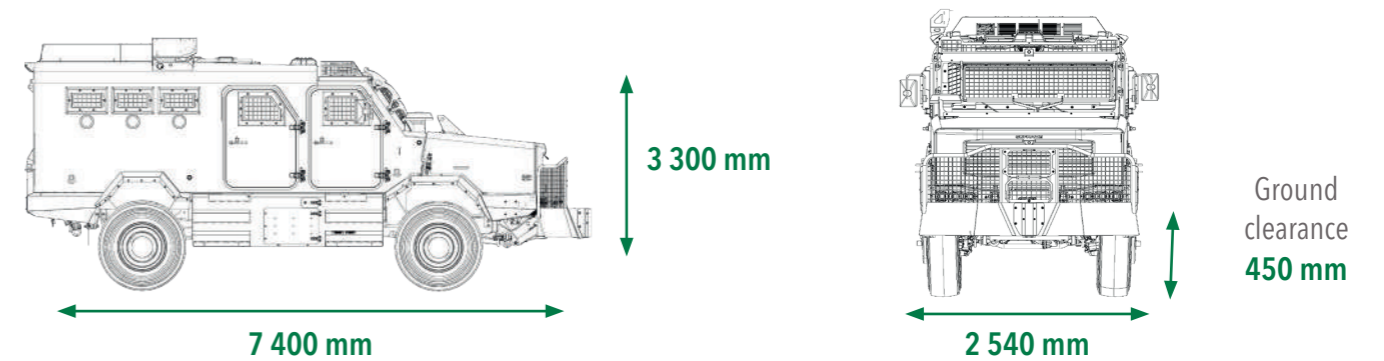

Slope  
40 %

Fording  
600 mm

Trench  
900 mm

Side Slope  
40 %

Step  
400 mm

**ARIVE** is a multi-purpose protected vehicle designed to carry an infantry combat group.

**Protected** against explosive devices and direct fire from infantry weapons as standard, its **spacious** design and **useful load capability** mean it can be used for long-term deployment in areas of insecurity.

Its habitability also means its interior design can be customised according to need, e.g. **command post, C4I processing relay, medical evacuation vehicle.**

Typically positioned on the MRAP (Mine Resistant Ambush Protected) segment, **ARIVE** covers a **vast panel of missions** ranging from infantry unit movements in combat zones to area control and counter-insurgency.

Its design enables to ford depths of 1.2 meters and clear routes blocked with obstacles.



Protection: level 2



Engine: 240 kW (330 hp)



Gearbox: Automatic



GVWR: 14.5 t



Maximum speed: 110 km/h



Range: 800 km



Turning radius: 8.5 m



Crew: 10 people + 2 crew

Around **2,000 ARIVE** vehicles are currently in active service. Its **robustness, mobility capabilities and reliability** have made it a benchmark vehicle.